

# 4 WHEEL ELECTRONIC STEERING COMBINATIONS

## LENGTHWISE TRAVEL

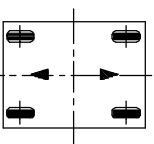

## NORMAL STEER (FRONT)

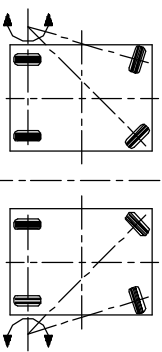

## NORMAL STEER (REAR)

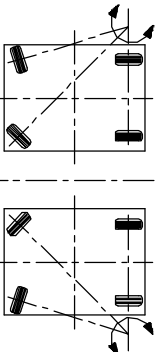

## ARC STEER

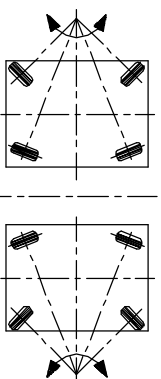

## CRAB TRAVEL

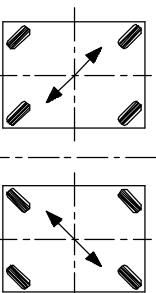

## PIVOT TURN

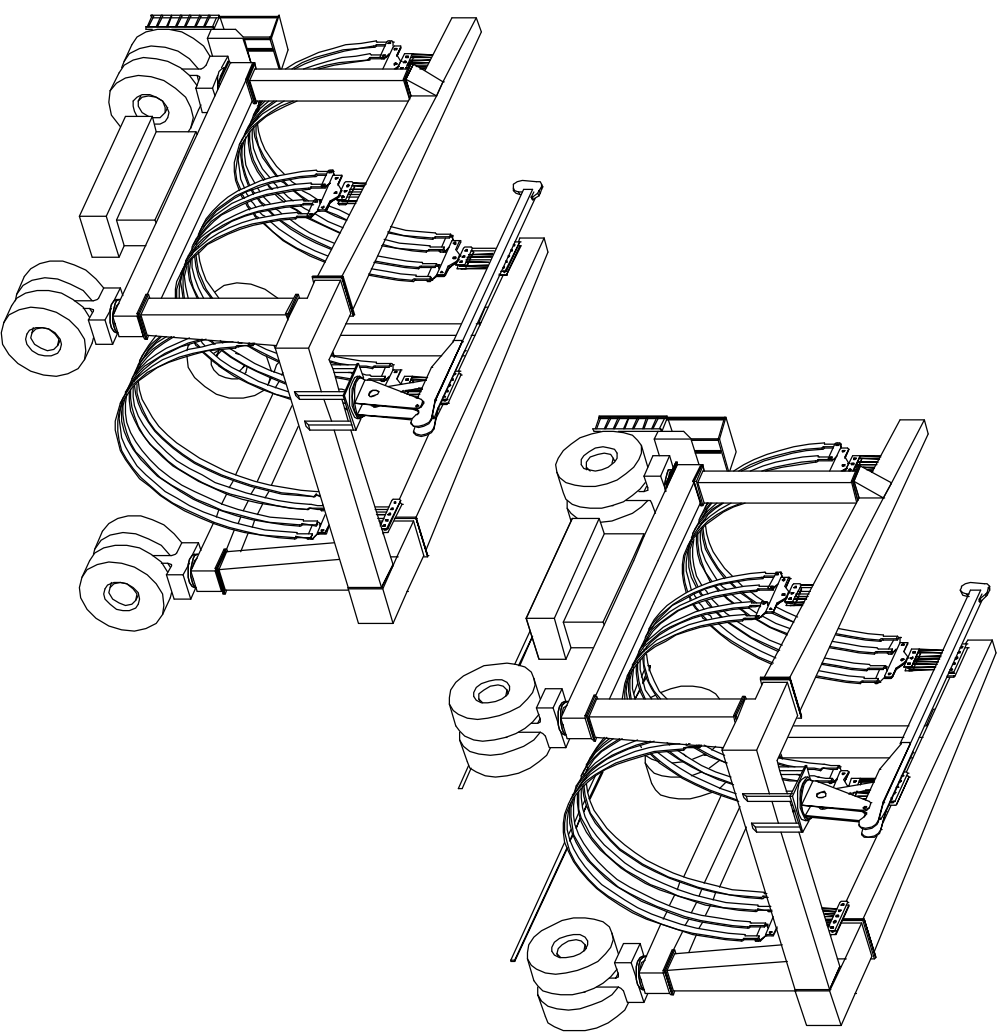
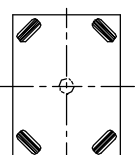

<b>Job No. 16317</b>		<b>GRIFF POINT ENGINEERING PTY. LTD.</b>	
DO NOT SCALE DRAWING		TITLE	
 Third Angle Projection		<b>4 WHEEL STEERING (MULTI-FUNCTION STEERING)</b>	
SCALE	---	DATE	03-09
DRAWN	AH	FOR 200 MSC 16W	
CHECKED		DRAWING NUMBER	
APPROVED	TED	REV.	
SHEET	1 OF 1	<b>16317-16W-MF-00</b>	